

## HIT Pendulum Impact Testers from 5 to 50 Joule



Intelligent Testing



## 1 ZwickRoell HIT – A striking solution

Together with tensile and flexure tests, Charpy impact tests are the most frequently performed mechanical tests in the polymer industry. ZwickRoell's HIT range of pendulum impact testers are available from 5 to 50 joules and offer a solution combining high precision with cost-effectiveness.

**"4-3-2-1"** is how ZwickRoell describes its wide range of products for Charpy, Izod and impact tensile tests on plastics. The pendulum impact testers are available in **four different versions** from 5 to 50 joule, making them suitable for all common standardized tests including Charpy and Izod.

In total, **three different automation solutions** are available from ZwickRoell for its HIT pendulum impact testers. All three solutions offer highly cost-effective, safe and reliable testing, and range from a specimen magazine (roboTest H), which can be attached to the pendulum impact tester, to a 6-arm industrial robot, which can also be combined with several pendulum impact testers. Another advantage of these automated testing solutions is that specimens can be temperature-conditioned, then tested within five seconds of being removed from the temperature-conditioning magazine.



Fig 1: Innovation center at ZwickRoell in Ulm, Germany

Reliable test results begin with proper preparation of the specimen. **Two different systems** are available from ZwickRoell; a manual notching plane and an automated notch-cutting machine for efficient, standard-compliant specimen preparation.

All tests involved are controlled and evaluated by **testXpert III**. testXpert III is a uniform testing platform for all applications and instruments.

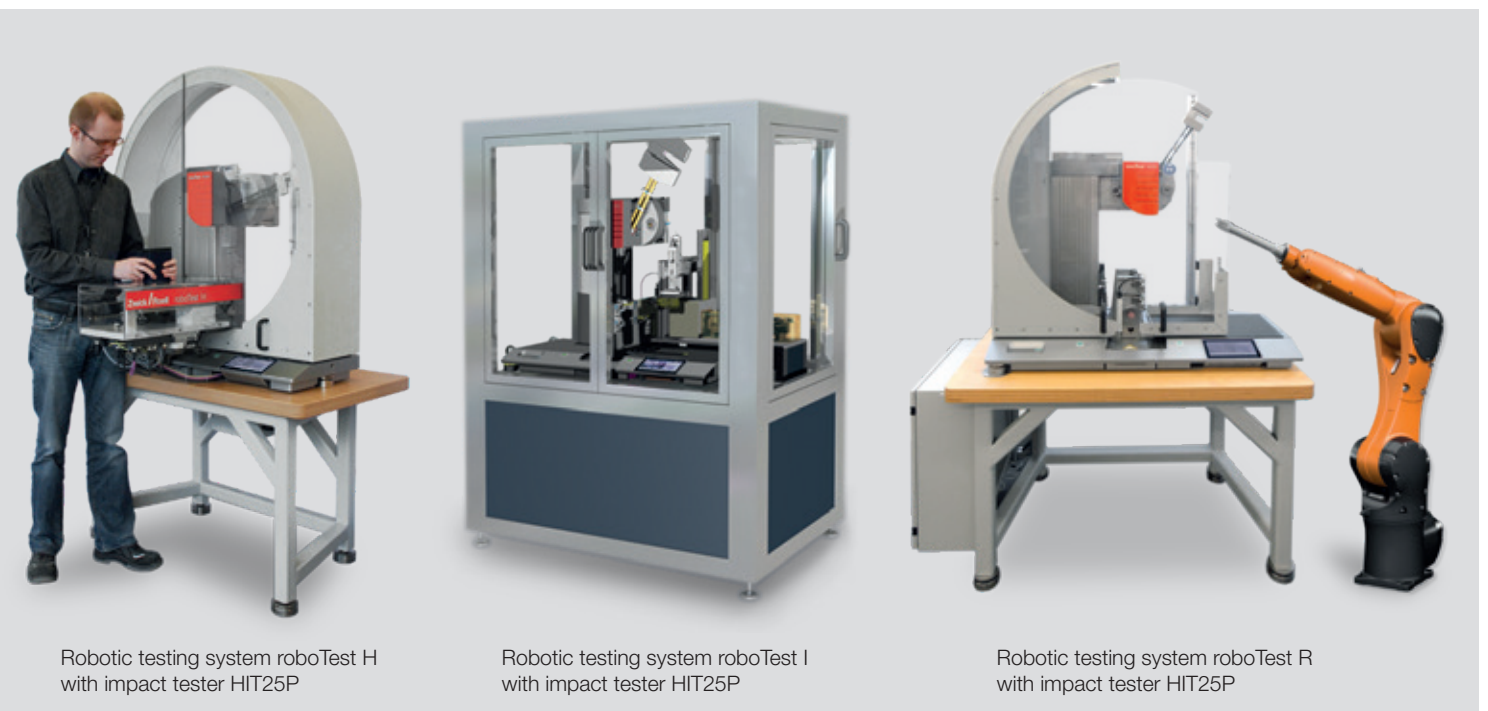

Robotic testing system roboTest H with impact tester HIT25P

Robotic testing system roboTest I with impact tester HIT25P

Robotic testing system roboTest R with impact tester HIT25P

## 2 Product features of the HIT pendulum impact testers

### With a PC or without – it's your choice

- **Intuitive and workflow oriented touch operation**

All test-related settings are grouped logically and are separated from higher-level system settings. The operator is guided through test configuration step by step. The stored test configuration can be easily exported and transferred to other devices.

- **Quick familiarization with user management also applies to stand alone**

Integrated user management reduces the number of operator input options to a minimum. Users see only what is important to them so they can focus on the task at hand right from the start.

- **Flexible use with or without PC**

Thanks to the new, standardized operating philosophy, the user can easily switch between the device and the PC.



Fig. 1: Intuitive and workflow oriented touch operation

### Reliable test results

The design of the ideal pendulum impact tester that consistently delivers low vibrations starts with the pendulums and fixtures, which are closest to the specimen.

ZwickRoell uses high-performance carbon materials for its **HIT pendulums**. These offer the following advantages:

- Significantly higher pendulum stiffness
- Ideal distribution of mass
- Repeatable, reproducible test results

You can test in a measurement range up to 80% of the potential energy. This is made possible by the very high ratio of instrument mass to pendulum mass.

Changing between the various HIT fixtures is quick, while precision guides guarantee a continuous positive-fit to the baseplate.

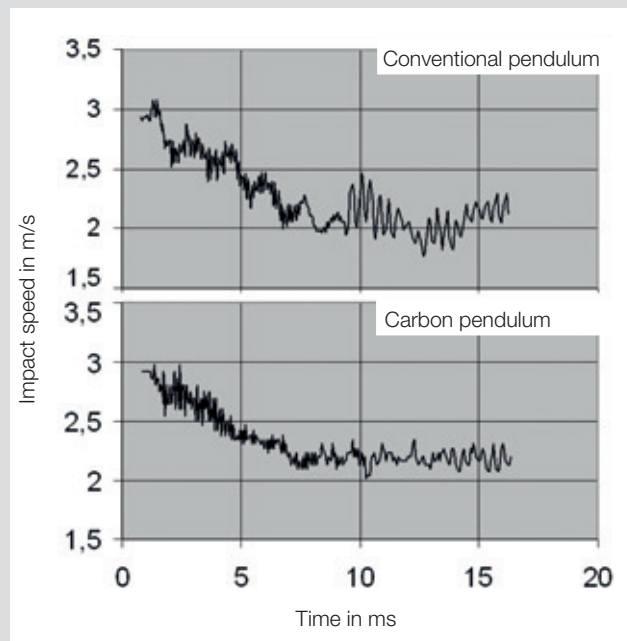

Fig. 2: Reduced inherent vibrations of the carbon fiber twin-rod pendulum



## Ergonomic design throughout

Ergonomics are center stage when it comes to the HIT pendulum impact testers. The operator benefits from everything being within arm's reach and operational controls that are at a uniform height.

- To change impact fixtures, simply slacken the retaining bolts slightly. The fixture can then be withdrawn from the guides and another slid into its place.
- The pendulum is easily changed by means of a quick release lock, eliminating the need for tools and simplifying the operation and saving time.
- Specimen dimensions can be easily entered using the touch display, or are directly transferred from the measurement devices.
- The type of failure can be immediately selected on the instrument after the test.

- The specimens are simply discarded into the integrated collection tray.
- The test results and the statistics can be viewed directly on the instrument display.



Fig. 1: The pendulum is easily changed by means of a quick release mechanism, eliminating the need for tools.

## Intelligent impact testing

Just as a calibrated weight has its mass engraved on it, each ZwickRoell pendulum carries its data with it in the form of electronically readable pendulum coding (Fig. 2).

The pendulum identifies itself to the electronics with data such as the standard, test type, energy capacity, starting angle and other physical data. Also stored in the instrument is the air and bearing friction data. Erroneous measurements are thus eliminated.

Freely selectable starting angles enable optimum test parameters to be achieved, for example impact speed and energy loss at impact. After the test, the pendulum is automatically captured and returned to the starting position by a motor drive.

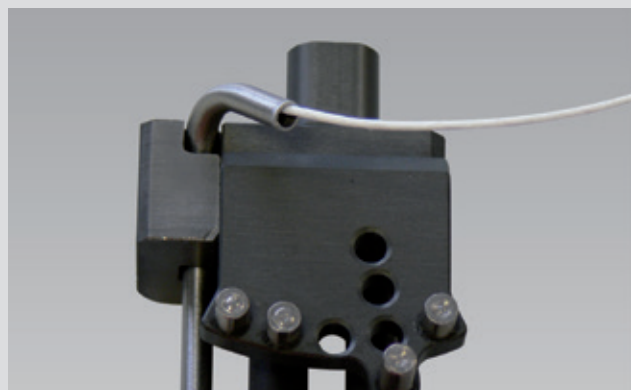

Fig. 2: Electronic pendulum coding



Fig. 3: HIT25P performing a Charpy impact test

## Suitable protection for every application

To protect operators from flying specimen fragments or prevent contact with a falling pendulum ZwickRoell recommends a range of solutions:

- During Charpy tests the safety guard on the Charpy fixture ensures that specimen remains stay within the pendulum impact tester.
- The left swiveling safety device enables optimum access, for example during Izod tests.
- The electrically interlocked safety device provides maximum protection from shattering specimens and eliminates the possibility of reaching into the pendulum impact tester during a test.



Fig. 1: HIT5P with safety housing fixed on the left and right



Fig. 2: Safety guard fixed on the left and right



Fig. 3: HIT5.5P safety housing is mounted on the right and can be swiveled to the left



Fig. 4: HIT50P electrically interlocked safety device

## Massive support frame and stable base

The welded table frame guarantees maximum stiffness, while wide-based leveling feet ensure firm, stable support.

The support table's positioning stops line up perfectly with the pendulum impact tester's frame. The HIT pendulum impact tester base plate is constructed with vibration-damping metal casting, and the ratio of its mass to the pendulum mass complies with standard requirements. Three sturdy, lockable leveling feet provide secure footing and enable horizontal alignment of the instrument.

This means that you can be sure of obtaining reliable test results regardless of local conditions.

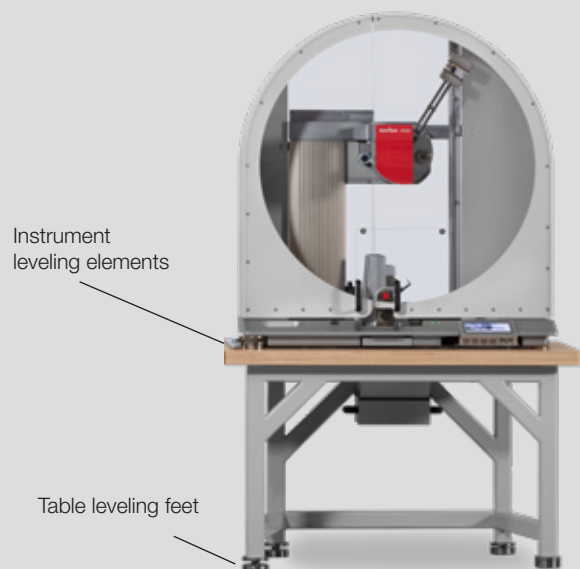

Fig. 5: Instrument table for the HIT pendulum impact testers

## Even more possibilities with testXpert III and instrumentation

ZwickRoell testing software provides a clear visual presentation of all impact characteristics recorded in a results table and graph, allowing you to produce comprehensive statistical evaluations.

Data is easily and safely stored:

- In a report prepared in accordance with the standard
- In a test series contained in testXpert III
- Automatically exported to your database

Instrumented impact testing allows additional information on material characteristic values and properties to be obtained, and fracture mechanics investigations and automated fracture evaluations to be performed. Instrumented pendulums and expanded electronics are available for high-accuracy recording of the high-speed processes involved in breaking through a specimen.

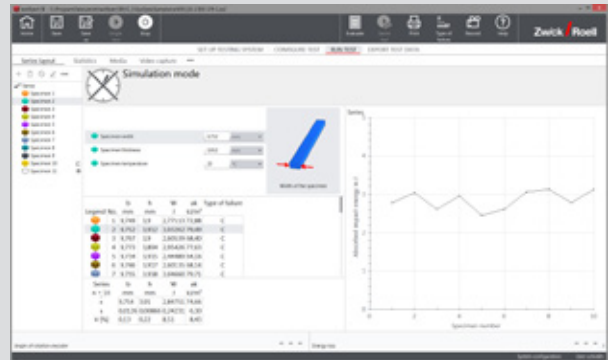

Fig. 1: Results table with associated graph

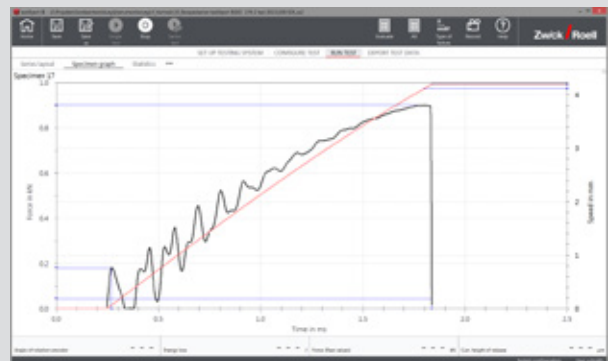

Fig. 2: Force-time curve with instrumentation

## Quick testing at low temperatures

At low temperatures impact strength is a critical property of a material. ZwickRoell offers a temperature-conditioning box and magazine for cooling specimens.



Fig. 3: Specimen cool box (open)



For testing at low temperatures the specimens are first conditioned in a cooling box. The magazine with the specimens is then attached to the specimen feeder, which is fastened to the HIT pendulum impact tester. This way the specimens can be quickly and conveniently removed and tested.

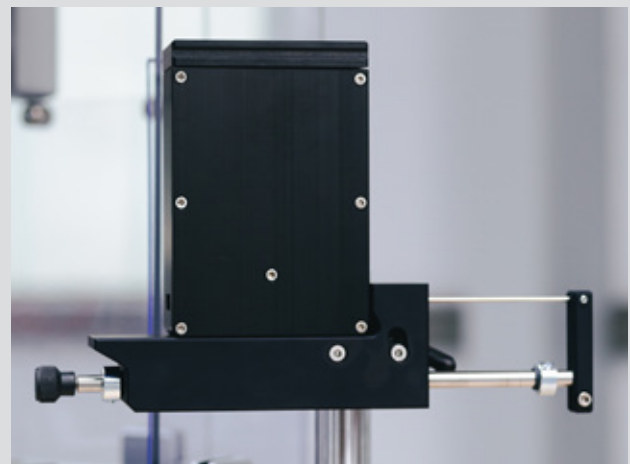

Fig. 4: For testing at low temperatures

## Standard-compliant testing of all test methods

HIT pendulum impact testers conform exactly to the requirements of international standards right down to the smallest detail, allowing users to rely on their instruments at all times.

Charpy, Izod, tensile impact method A and B and Dynstat can be easily performed with the pendulum impact testers and the user can quickly switch between the procedures.

The support fixtures for the various methods are stored securely in a dovetail guide. To change over, a few screws are slackened slightly and the fixture is pushed out.

Dependable limit switch stops ensure exactly reproducible positioning. The pendulum is easily changed by means of a quick release lock, no additional tools are required, simplifying operation and saving time.

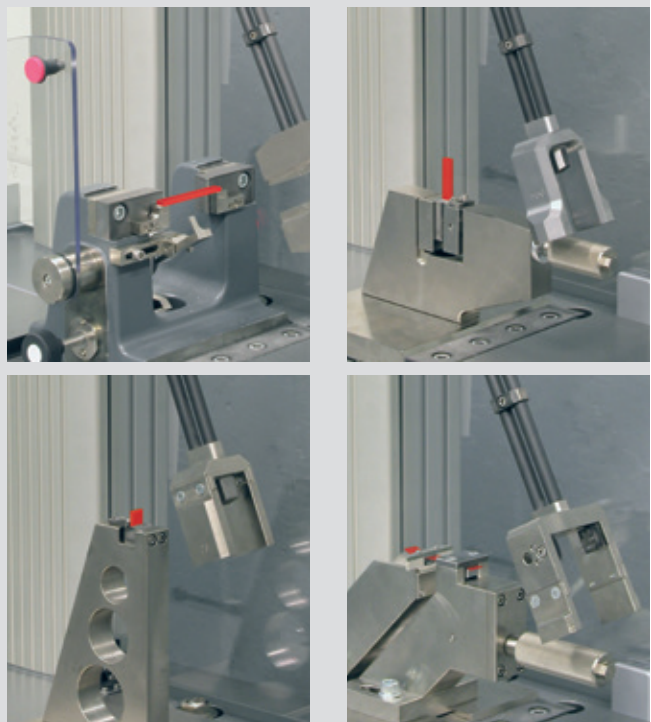

Fig. 1: Easy selection of all these methods

## Upgradeable for automation

Automatic specimen feeding or handling systems are used extensively in research and development where there is a requirement for statistically dependable material characteristic values. Specimen feeding systems are upgradeable in various task-specific versions.

### • roboTest R

The industry-robot is in charge of loading the impact-samples to the pendulum-impact-tester, no matter if just one tester or multiple.

As option available is temperature-chamber, measuring remaining-width or notch-milling-machine, all fully-automatic of course.

### • roboTest H

Up to 20 specimens are transported quickly and reliably from a precooled magazine. Less than 3 seconds elapse between removal from the magazine and impact. Magazines can be changed very quickly.



Fig. 2: roboTest H with HIT25P



## Specimen preparation

ZwickRoell's **ZNO automatic notch-cutting machine** provides standard-compliant notching of your plastics specimens. The operator-friendly display allows fast, step-free setting of new parameters, for example, cutting speed and feed-rate; a cutting-head is used for optimum production of a V-shaped notch on one side of the specimen. Various cutters are available for different materials and notch radii, and are easy to change.

Additional specimen preparation features:

- Plexiglass safety hood
- Manual notch-depth setting via fine-pitch screw-adjuster
- Connection for external compressed air supply for specimen cooling

Sturdy construction combined with safe, simple and reliable operation make the ZwickRoell notch-cutting machine the ideal tool for producing notched specimens from all types of plastic.

For smaller specimen volumes ZwickRoell's **manual notch-cutter** is the instrument of choice. The removable specimen magazine allows you to notch up to four specimens simultaneously, while the durable notch-cutter blade can be quickly changed. Once the remaining width specified in the standard has been attained, the feed is stopped automatically.

Linking the feed and the notching motion ensures reproducibility, even with different operators.

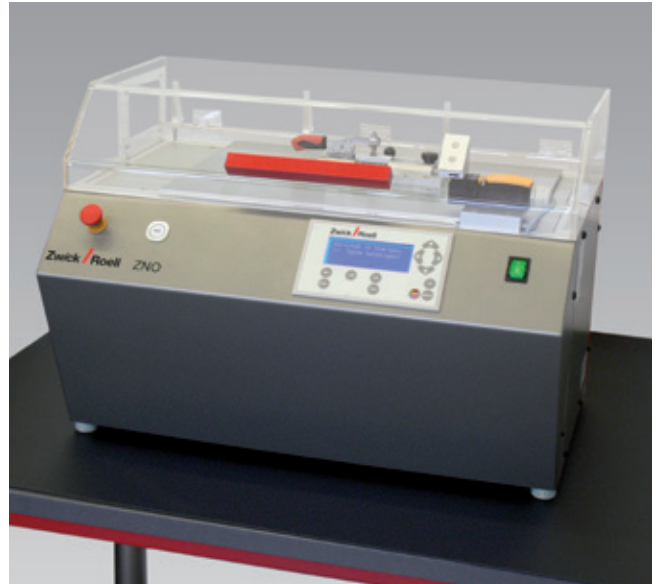

Fig. 1: Notch cutting machine ZNO with closed safety hood



Fig. 2: Manual notching plane

Standard	Shape A	Shape B	Shape C
ISO 179-1	single or double notch	single or double notch	single or double notch
ISO 180	single notch	single notch	-
ISO 8256-1	double notch	-	-
ASTM D 256	single notch	-	-
ASTM D 6110	single notch	-	-
Sketch			
Radius of notch root	0.25 mm ± 0.05 mm	1.00 mm ± 0.05 mm	0.10 mm ± 0.02 mm

Fig. 3: The quality of the specimen notching has a considerable bearing on test results. The figure above shows an overview of specimen shapes.

## 3 Applications

### 3.1 Charpy tests

The Charpy fixture comprises a heavy cast iron base. Test-specific accessories, such as supports and anvils, are selected according to the specimen to be tested.

The surface finish and radius of the anvils used can significantly affect the accuracy of the test results. ZwickRoell anvils are completely manufactured on CNC machines and checked for 100% dimensional accuracy. We do not supply one-piece anvils, as these may have low dimensional accuracy.

An optional jig ensures the anvils are accurately positioned relative to the tup.

Since anvils are subject to greater wear than supports, they are designed to be easily and inexpensively replaced independent of the supports or adapter plates. Quick-change adapter plates are used to adapt the pendulum impact tester to different specimen widths. Different specimen (vertical) dimensions are accommodated by using appropriate-sized Charpy supports precisely positioned via set pins.

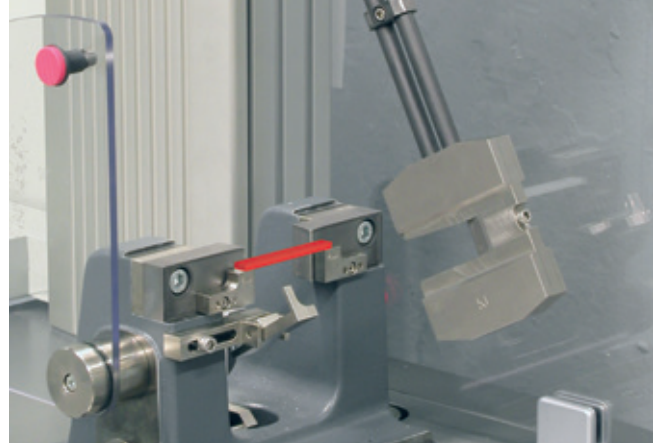

Fig. 1: Notch alignment unit on a Charpy fixture

An optional swiveling protective shield can be used with the fixture, and a positioning aid helps to locate the specimen correctly, using either the notch or the front edge of the specimen.

#### Advantages:

- Quick changing of Charpy fixture
- Anvils precision-made by CNC machine and individually inspected for 100% accuracy

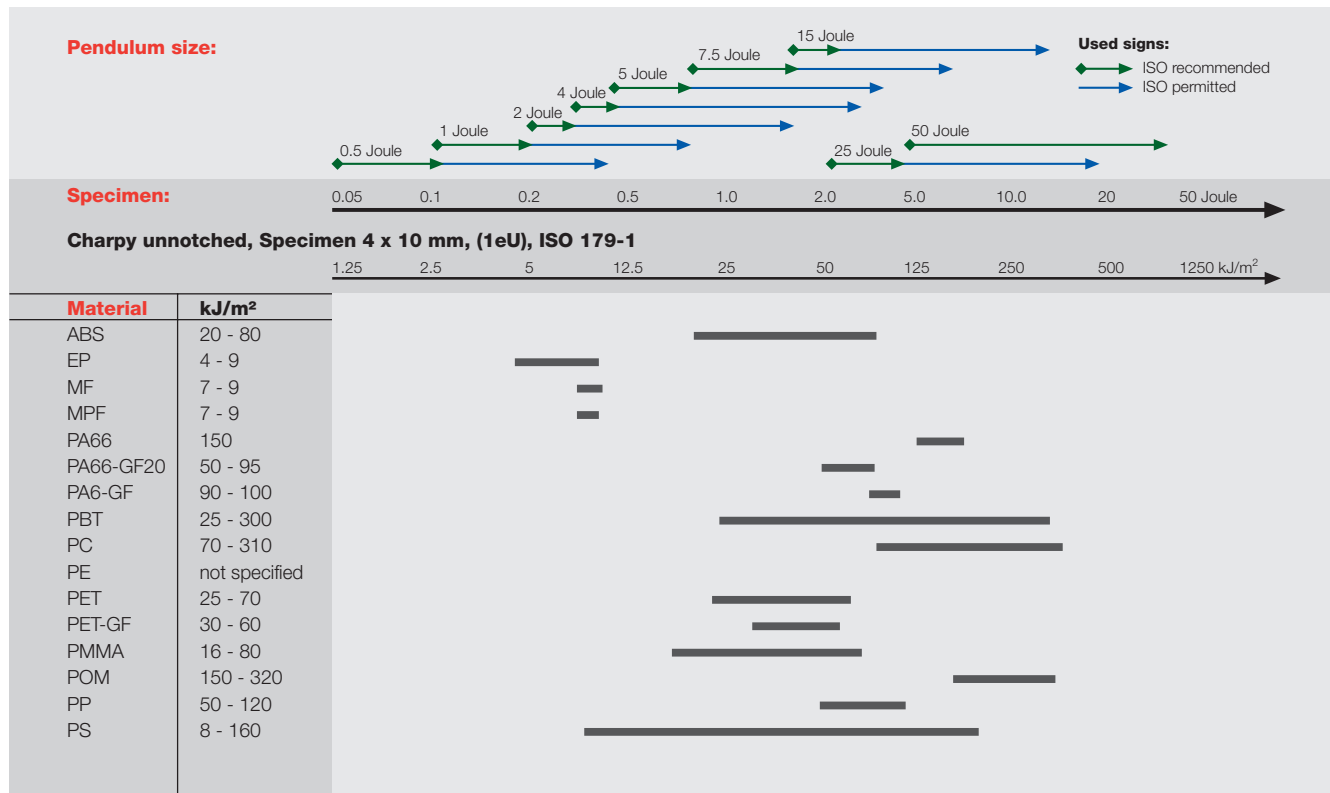

Fig. 2: Indicated values for Charpy impact resilience are only valid for unnotched specimen, 10 x 4 mm.

## 3.2 Izod tests

Two types of Izod fixtures can be used: The manual fixture clamps the specimen via a fine-threaded lead screw, ensuring optimum gripping force is applied, whether to sensitive, soft or hard specimens.

The pneumatic vise is ideal if a high throughput is required, or if temperature-conditioned specimen are to be tested. A further advantage is its high clamping force reproducibility, which leads to excellent test results on materials which are sensitive to clamping forces.

Quick clamping via a switch on the fixture minimizes the time between removing the specimen from the temperature unit and the performance of the test.

Both fixtures are equipped with a centering unit, which ensures that the specimen is always positioned at notch root level.

Positioning of the sample relative to its width in the impact direction is achieved via quick-change inserts with lateral guides.



Fig. 1: Test with the manual Izod fixture clamp

### Advantages:

- Quick centering and gripping of specimen
- Fine adjustment of specimen clamping force
- Quick testing using the pneumatic fixture
- High test result reproducibility due to the constant clamping force

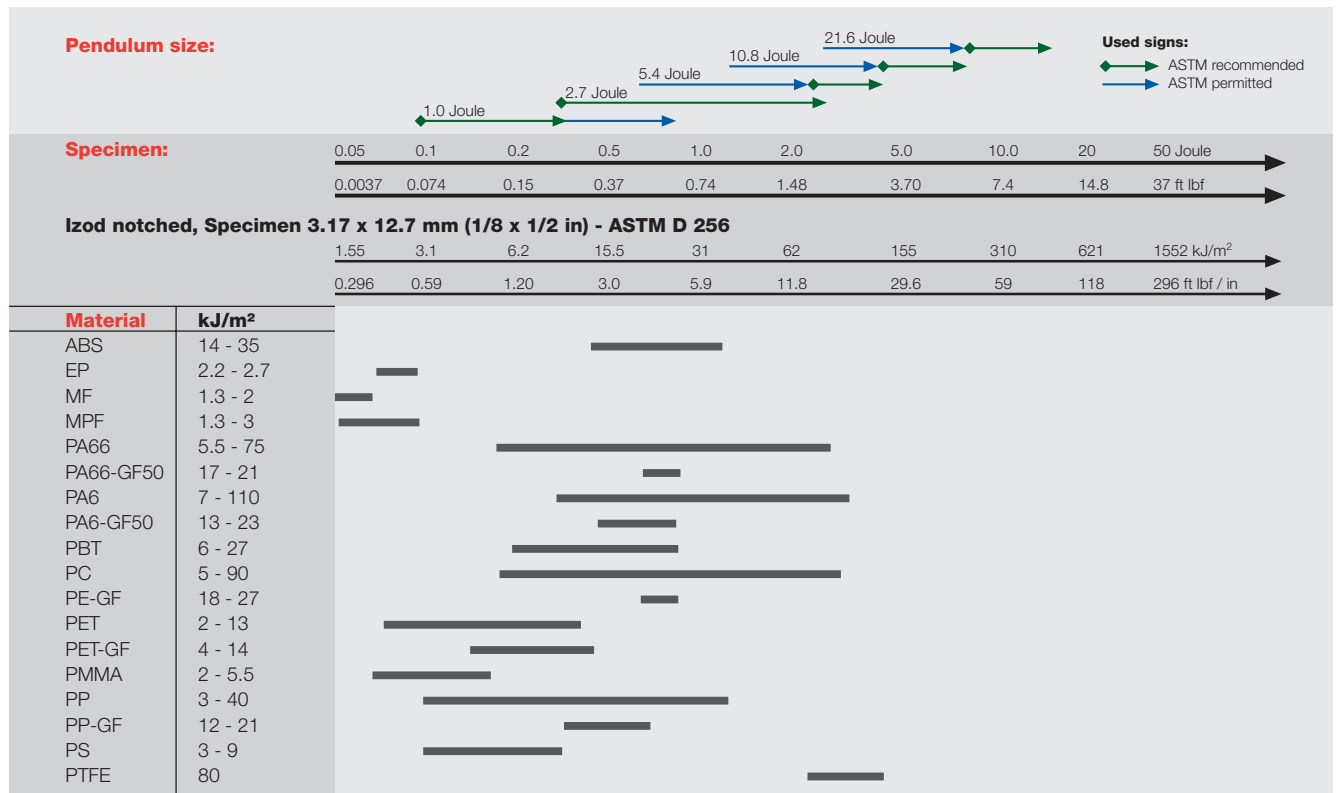

Fig. 2: Indicated values for Izod impact resilience according to ASTM standard are only valid for specimen cross-sections of 1/8" x 1/2" (3.17 x 127 mm).

## 3.3 Impact tensile tests

Specimen and yoke are assembled in a jig.

Depending on the testing method being used, the specimen and yoke are clamped in either the pendulum or the impact tensile fixture.

The appropriate template can be selected for ISO and ASTM specimens.

For tests according to ISO 8256 Method A one specimen shoulder is gripped by a yoke. The other end of the specimen is clamped in the impact tensile fixture.

The pendulum strikes the yoke, effecting a tensile impact on the free end of the specimen. Yokes with masses of 15 to 120 g are available.

For tests according to ISO 8256 Method B and ASTM D 1822, one specimen end is gripped in the pendulum. The other end of the specimen carries a yoke and hangs free. During the test, the free end with the yoke strikes the impact tensile fixture.

A fixture is available for each standard. Yokes from 15 g to 120 g are available.

### Advantages:

- Rapid configuration changes between the two different test methods.
- Precise sample alignment and clamping

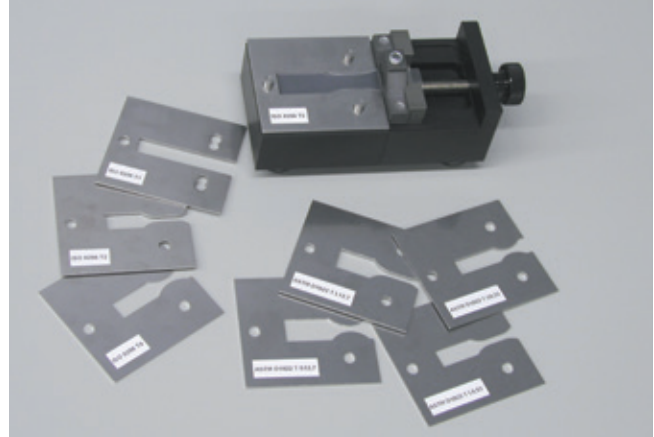

Fig. 1: Clamping jig and templates for the impact tensile test

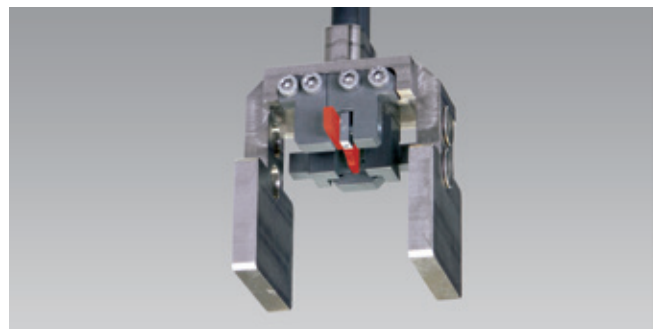

Fig. 2: Impact tensile specimen in pendulum - ASTM D 1822

## 3.4 Dynstat testing

The HIT pendulum impact testers can also be equipped for Dynstat tests to DIN 53435. ZwickRoell offers a Dynstat fixture and a comprehensive range of pendulums for Dynstat applications.

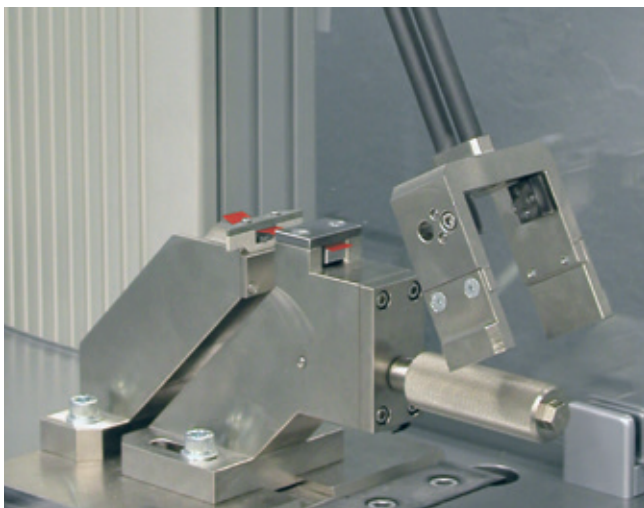

Fig. 3: Fixture for impact tensile tests, Method A



Fig. 4: Dynstat fixture





## 3.5 Overview of HIT pendulum impact testers with possible applications

Test type	Standard	Energy		Impact speed (m/s)	Drop height (mm)	Pendulum length (mm)	Pendulum release (°)	Pendulum mass (kg)	HIT5P	HIT5.5P	HIT25P	HIT50P		
		(J)	(ft*lbf)											
Charpy	ISO 179	<b>0.5</b>	0.37	<b>2.9 (± 10 %)</b>	(428.98)	250	135.72	0.119	•					
		<b>1</b>	0.74											
		<b>2</b>	1.48											
		<b>4</b>	2.95											
		<b>5</b>	3.69											
		<b>0.5</b>	0.37	<b>2.9 (± 10 %)</b>	(429.01)	330	107.46	0.119	0.238	•	•	•	•	•
		<b>1</b>	0.74											
		<b>2</b>	1.48											
		<b>4</b>	2.95											
		<b>5</b>	3.69											
	<b>7.5</b>	5.53	<b>3.8 (± 10 %)</b>	(739.07)	400	147.96	1.035	2.070	•	•	•	•	•	
	<b>15</b>	11.1												
	<b>25</b>	18.4												
	<b>50</b>	36.9												
	ASTM D 6110		<b>0.5</b>	0.37	(3.46)	<b>610 (± 2 mm)</b>	330	147.96	0.084	•	•	•	•	
<b>1</b>			0.74											
<b>2.7</b>			2											
<b>5.4</b>			4											
<b>10.8</b>			8											
<b>21.6</b>	16													
Izod	ISO 180	<b>1</b>	0.74	<b>3.5 (± 10 %)</b>	(609.73)	330	147.96	0.167	•	•	•	•		
		<b>2.75</b>	2.03											
		<b>5.5</b>	4.06											
		<b>11</b>	8.11											
		<b>22</b>	16.2											
	ASTM D 256 / ASTM D 4812		<b>1</b>	0.74	(3.46)	<b>610 (± 2 mm)</b>	330	147.96	0.226	•	•	•	•	
			<b>2.75</b>	2.03										
			<b>5.5</b>	4.06										
			<b>11</b>	8.11										
			<b>22</b>	16.2										
Impact Tensile	ISO 8256-A	<b>2</b>	1.48	<b>2.9 (± 10 %)</b>	(428.98)	250	135.72	0.475	•					
		<b>4</b>	2.95											
	ISO 8256-A / ISO 8256-B		<b>2</b>	1.48	<b>2.9 (± 10 %)</b>	(429.01)	330	107.46	0.475	•	•	•	•	
			<b>4</b>	2.95										
			<b>7.5</b>	5.53	<b>3.8 (± 10 %)</b>	(739.07)	400	147.96	1.035	2.070	•	•	•	•
			<b>15</b>	11.1										
			<b>25</b>	18.4										
	<b>50</b>	36.9												
	ASTM D 1822		<b>1.35</b>	1	(3.46)	<b>610 (± 2 mm)</b>	330	147.96	0.226	•	•	•	•	
			<b>2.7</b>	2										
			<b>5.4</b>	4										
			<b>10.8</b>	8										
			<b>21.6</b>	16										
	Dynstat	DIN 53435	<b>0.2</b>	0.15	<b>2.2 (± 0.1 m/s)</b>	(246.86)	250	89.28	0.083	•	•	•	•	
			<b>0.5</b>	0.37										
<b>1</b>			0.74											
<b>2</b>			1.48											
<b>4</b>			2.96											
Charpy (for metals)	ASTM E 23 withdrawn Standard DIN 50115	<b>50</b>	36.9	<b>3.8 (± 10 %)</b>	(739.07)	400	147.96	6.899	•			•		
		<b>7.5</b>	5.53										<b>3.8 (± 10 %)</b>	(739.07)
		<b>15</b>	11.1											
		<b>25</b>	18.4											
		<b>50</b>	36.9											

## 4 Instrument specifications

The specification guide on the following pages is designed to help you to configure your instrument to meet your testing requirements.



This page shows a table containing technical data for the various versions of the basic instrument.

Pendulum impact tester	HIT5P	HIT5.5P
		
	• <b>1064343</b>	• <b>1064347</b>
Max. impact energy	<b>5 J</b>	<b>5.5 J</b>
Dimensions (W x H x D)	680 x 658 x 404 mm (without safety device)	870 x 920 x 500 mm (without safety device)
Weight (w/o accessories)	approx. 75 kg	approx. 137 kg
Power supply	100 - 240 V, 50/60 Hz, 70 W	100 - 240 V, 50/60 Hz, 70 W
Interfaces	RS232, USB	RS232, USB
Impulse resolution	0.018°	0.018°
Test results, numeric	impact energy [%] impact energy [J; ft lbf] impact strength [kJ/m <sup>2</sup> ; ft lbf/in <sup>2</sup> ]	impact energy [%] impact energy [J; ft lbf] impact strength [kJ/m <sup>2</sup> ; ft lbf/in <sup>2</sup> ]
Control functions	pendulum vertical position swing duration	pendulum vertical position swing duration device data display
Correction functions	friction correction impact tensile test: kinetic air and bearing friction yoke energy	friction correction impact tensile test: kinetic air and bearing friction yoke energy

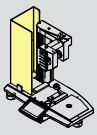
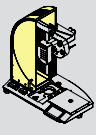
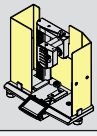
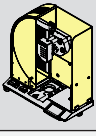
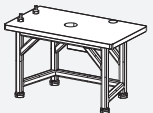
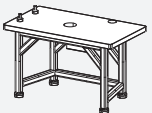
### Options

Protection		
	Safety housing, fixed on the left • <b>010924</b>	
	Safety housing, fixed on the left and right • <b>010926</b>	
<b>Device table</b>	Table with specimen collection tray Weight: 115 kg 1200 x 710 mm  • <b>326058</b>	Table with specimen collection tray Weight: 115 kg 1200 x 710 mm  • <b>326058</b>

Item numbers are indicated by a red dot (•). Depending on the basic instrument additional options are available, including safety devices, support tables, instrumentation and connection to ZwickRoell testing software.

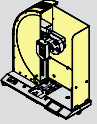
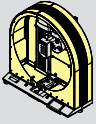
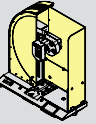
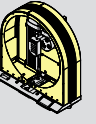
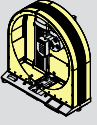
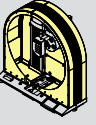
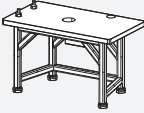
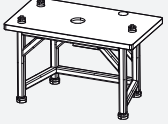
HIT25P		HIT50P	
 <p>with pendulum lifting</p>		 <p>with pendulum lifting</p>	
• 1064351	• 1064349	• 1064353	• 1064348
<b>25 J</b>		<b>50 J</b>	
1080 x 1170 x 500 mm (with safety device)		1080 x 1170 x 500 mm (with safety device)	
approx. 258 kg	approx. 2278 kg	approx. 258 kg	approx. 278 kg
100 - 240 V, 50/60 Hz, 70 W	100 - 240 V, 50/60 Hz, 150 W	100 - 240 V, 50/60 Hz, 70 W	100 - 240 V, 50/60 Hz, 150 W
-RS232, USB		RS232, USB	
0.018°		0.018°	
impact energy [%] impact energy [J; ft lbf] impact strength [kJ/m <sup>2</sup> ; ft lbf/in <sup>2</sup> ]		impact energy [%] impact energy [J; ft lbf] impact strength [kJ/m <sup>2</sup> ; ft lbf/in <sup>2</sup> ]	
pendulum vertical position swing duration device data display		pendulum vertical position swing duration device data display	
friction correction impact tensile test: kinetic air and bearing friction yoke energy		friction correction impact tensile test: kinetic air and bearing friction yoke energy	
 <p>Safety housing, left and right <i>(included in scope of supply)</i></p>	 <p>Safety device, electrically interlocked <i>(included in scope of supply)</i></p>	 <p>Safety housing, left and right <i>(included in scope of supply)</i></p>	 <p>Safety device, electrically interlocked <i>(included in scope of supply)</i></p>
 <p>Safety device • 016674</p>		 <p>Safety device • 016674</p>	
Table with specimen collection tray Weight: 115 kg 1200 x 710 mm  		Table with specimen collection tray Weight: 260 kg 1280 x 710 mm  	
• 326058		• 326104	

## Additional options:

### Instrumentation

Instrumentation is available for Charpy, Izod and impact tensile tests and can be used with HIT5.5P, HIT25P and HIT50P pendulum impact testers. Components required for performing instrumented impact tests are as follows:

- Measured-value acquisition
- Instrumented impact pendulum for Charpy/Izod
- Instrumented fixture for impact tensile
- testXpert III software for instrumented impact tests.

Compared to conventional impact pendulums, the instrumented version possesses a very wide measurement range, which is defined as force rather than as an energy value. This means that impact pendulums with a high energy capacity can also be used to measure very low impact strengths. The advantage is virtually constant speed during specimen penetration and the near elimination of the need for pendulum changes. Because even brittle materials require relatively high impact forces and the instruments possess a very wide measured value acquisition frequency, any restrictions on the measurement range are imposed by the natural frequency of the measuring system and the impact speeds specified by the standards. In the case of Charpy tests, an instrumented 5-joule impact pendulum (2.9 m/s) and a 50-joule impact pendulum (3.8 m/s) are enough to cover the entire measurement range of all conventional impact pendulums.

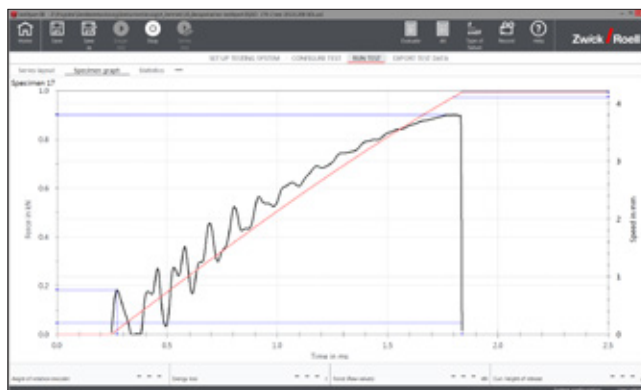

Fig. 1: Force-Time graph with instrumentation

### Card for measured-value acquisition for instrumented impact tests

• 021759

For determination of the force-travel-time sequence a force sensor and quick measured value acquisition are used.

The data recording unit makes it possible to record, for example, a load signal during impact test.

Features of the data recorder:

- High performance A/D converter with 16 bit resolution
- Two independent, configurable data channels
- Measurement frequency up to 4 MHz per channel
- Ratiometric measurement ensures maximum measurement accuracy
- Memory depth up to 200.000 data points per channel
- Independently programmable trigger methods (e.g. angle of rotation)

## ZwickRoell testing software

testXpert III comprises Master and Standard Test Programs for optional use with all HIT models.

### testXpert III Test Programs

Master Test Program for pendulum impact tests: connects ZwickRoell pendulum impact testers with the functions required for the pendulum impact tester configuration in use **• 1035784**

#### Standard Test Programs for tests on **plastics:**

to DIN 53435 (Dynstat) pendulum impact tests on plastics **• 1035789**

to ISO 179-1 (Charpy), ISO 180 (Izod), ISO 8256 (tensile impact) pendulum impact test on plastics **• 1035790**

to ISO 179-2 06/2000, determination of Charpy impact properties on plastics, instrumented impact test **• 1035837**

to ASTM D 6110 (Charpy), ASTM D 256, ASTM D 4812 (Izod), ASTM D 1822 **• 1035791**

#### Standard Test Programs for tests on **metals:**

to DIN 50115 (withdrawn), pendulum impact test on metal **• 1035800**

to ASTM E23, for notched bar impact testing of metallic materials **• 1035932**



## Pendulum release units for various standards

Two release units are available. The mechanical release unit is suitable for general purpose testing, and the pneumatic version is recommended for high specimen throughput.

Different impact speeds are required according to standard and method. For this reason pendulums vary in length and are designed for three different starting angles from two different release positions. Each pendulum is only ever suitable for one starting angle, preventing operator error.

	HIT5P	HIT5.5P	HIT25P/50P	HIT25P/50P with pendulum lift
<b>Pendulum brake</b> disk brake, manually operated	-	• 325704	included in the scope of supply	-
<b>Pendulum brake</b> automatically	-	-	-	included in the scope of supply
<b>Starting angle</b> , according to: DIN 53435, ISO 179, ISO 8256	included in the scope of supply	• 325924	included in the scope of supply	included in the scope of supply
<b>Starting angle</b> , according to: ISO 180, ASTM D6110, ASTM D256, ASTM D4812, ASTM D1822	not required	• 325926	included in the scope of supply	included in the scope of supply
<b>Release unit</b> , mechanical	included in the scope of supply	• 325702	-	-
<b>Release unit</b> , pneumatic	-	• 325700	included in the scope of supply	included in the scope of supply

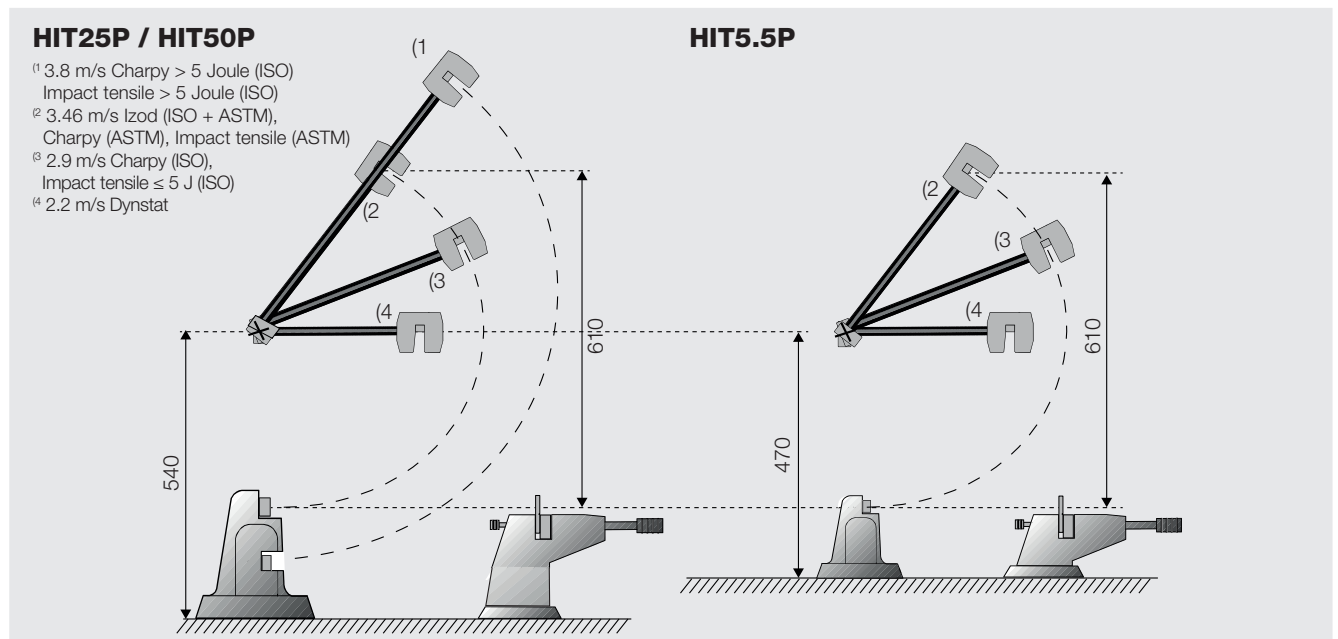
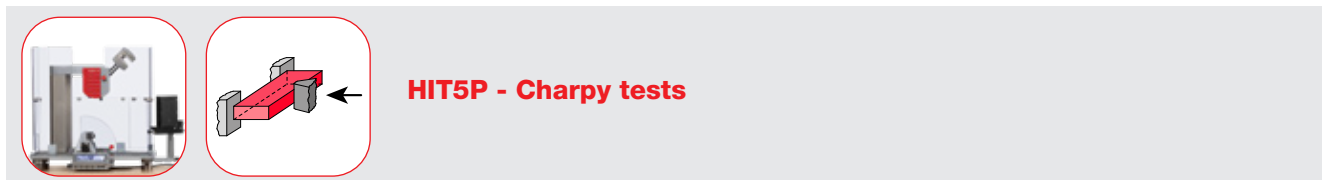

Fig. 1: Drawing of the different support heights and start angles at the HIT Pendulum Impact Testers

## 4.1 Testing plastics



### Selecting impact pendulums

As well as specifying the working range, which lies between 10% and 80% of potential energy, the ISO standards also stipulate that the largest appropriate impact pendulum from the series of standards must always be used for the test. Due to the narrow overlap between the ranges of use, pendulum changes are required relatively frequently in practice. To meet this demand, HIT pendulum impact testers are equipped with a quick-change device. Pendulum changes are performed in seconds and thanks to the automatic pendulum identification technology, without any further input from the operator.

To avoid the risk of confusion, the use of add-on weights to increase the energy capacity are generally not used by ZwickRoell. In the case of Charpy impact tests to ISO standards it is usually possible to dispense with the use of the 4-joule pendulum.

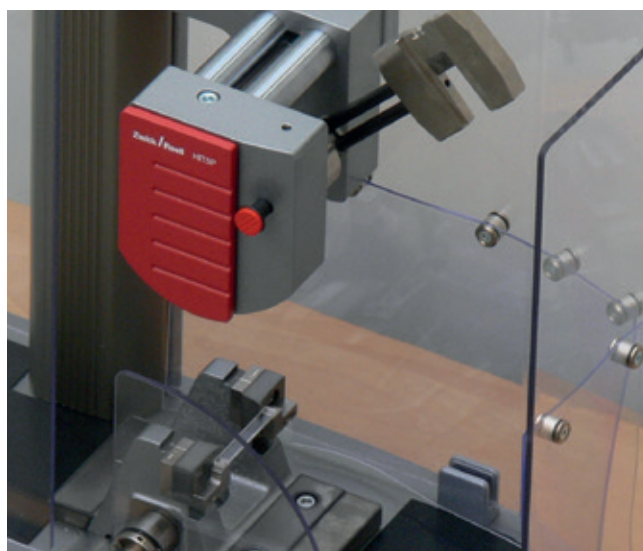

Fig. 1: HIT5P equipped with a Charpy pendulum and fixture



Standard	Impact energy	Pendulum	Impact velocity
ISO 179-1	0.5 J	• <b>010930</b>	2.9 m/s
	1 J	• <b>010932</b>	2.9 m/s
	2 J	• <b>010940</b>	2.9 m/s
	4 J	• <b>010941</b>	2.9 m/s

### Charpy fixture and accessories

A local operator protection with notch alignment is available as an option for the Charpy fixture. The notch alignment unit is required to align the specimen notch with the center of impact.

When using the side alignment unit, the specimens are aligned to their front faces. The available stop can be swiveled.

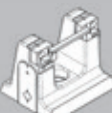

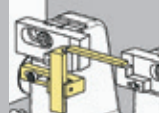
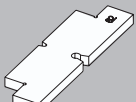

Jigs are for adjustment of the anvils and adjustment of the tup to the anvils.

			
<b>Charpy fixture</b> • <b>010961</b>	<b>Local operator protection and notch alignment unit</b> • <b>014988</b>	<b>Side alignment unit</b> • <b>010965</b>	<b>Jig to ISO 179</b> • <b>016126</b> For adjustment of anvil span spacing to 62 mm

## Adapter plates, supports and anvils

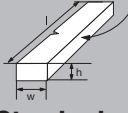
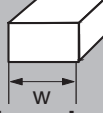
In addition, supports and anvils are to be determined with respect to the specimen. Dimension w in the table is the specimen's dimension in the direction of impact;

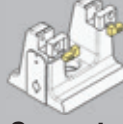
dimension h is the dimension in direction of the pendulum center of rotation. Each impact fixture should be equipped with adapter plates, supports and anvils.

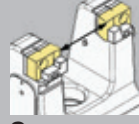
 Standard	 Dimension w	 Adapter plate	 Dimension h	 Support	 Anvil	 Span
ISO 179-1	10 mm	• 010945	4 mm	• 325730	• 010955	62 mm
	4 mm	• 010947	10 mm	• 325734	• 010955	62 mm
	15 mm	-	3 mm	• 325728	• 010958	22 ... 70 mm
	10 mm	• 010945	3 mm	• 325728	• 010958	22 ... 70 mm
	3 mm	• 010951	15 mm	• 325736	• 010958	22 ... 70 mm
	3 mm	• 010951	10 mm	• 325734	• 010958	22 ... 70 mm

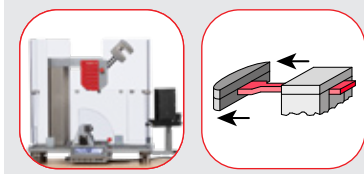

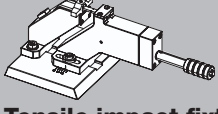
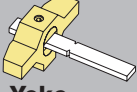

## HIT5P - Tensile impact tests

## Tensile impact fixtures, yokes and pendulums

 Standard	 Tensile impact fixture	 Yoke	Mass	Impact energy, pendulum	Impact velocity
ISO 8256-A	• 010967	• 325684	15 g	2 J	• 010968
		• 325686	30 g	4 J	• 010970

## Clamping units for tests to ISO 8256

Simplifies effective clamping of the specimen in the yoke. Clamping template and jig are required.

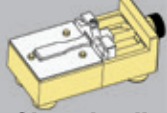
 Standard	 Specimen type	 Clamping template	 Clamping jig
ISO 8256	Type 1	• 325672	• 325798 (Clamping jig can be used for all types of standards)
Method A	Type 2	• 325674	
	Type 3	• 325676	
	Type 4	• 325678	

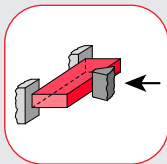

## HIT5.5P - Charpy tests

### Selecting impact pendulums

As well as specifying the working range, which lies between 10% and 80% of potential energy, the ISO standards also stipulate that the largest appropriate impact pendulum from the series of standards must always be used for the test. Due to the narrow overlap between the ranges of use, pendulum changes are required relatively frequently in practice. To meet this demand, HIT pendulum impact testers are equipped with a

quick-change device. Pendulum changes are performed in seconds and thanks to the automatic pendulum identification technology, without any further input from the operator.

To avoid the risk of confusion, the use of add-on weights to increase the energy capacity are generally not used by ZwickRoell. In the case of Charpy impact tests to ISO standards it is usually possible to dispense with the use of the 4-joule pendulum.



Standard	Impact energy	Conventional pendulum	Instrumented pendulum	Impact velocity
ISO 179-1 (conventional)	0.5 J	• <b>325738</b>	-	2.9 m/s
ISO 179-2 (instrumented)	1 J	• <b>325740</b>	-	2.9 m/s
	2 J	• <b>325742</b>	• <b>021764</b>	2.9 m/s
	4 J	• <b>325744</b>	-	2.9 m/s
	5 J	• <b>325746</b>	• <b>021768</b>	2.9 m/s
	ASTM D 6110	0.5 J (0.37 ft lbf)	• <b>325762</b>	-
	1 J (0.74 ft lbf)	• <b>325764</b>	-	3.46 m/s
	2.7 J (2 ft lbf)	• <b>325766</b>	• <b>021781</b>	3.46 m/s
	5.4 J (4 ft lbf)	• <b>325768</b>	• <b>021782</b>	3.46 m/s
<b>Pendulum sets</b>				
ISO 179-1	4 J and 5 J	• <b>325748</b>	-	2.9 m/s
ASTM D 6110	2.7 J and 5.4 J (2 ft lbf and 4 ft lbf)	• <b>325770</b>	-	3.46 m/s

### Charpy fixture and accessories

A local operator protection with notch alignment is available as an option for the Charpy fixture. Two alignment units are also available; these differ according to how the notch is produced. If notching is carried out with a lateral stop, there is a fixed distance between the side of one specimen and the notch. In this case the lateral

alignment unit is the more practical solution, being quick and reliable.

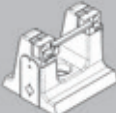
If there is no fixed distance between notch and specimen side, it is necessary to center directly on the specimen. In this case, the central notch alignment unit is required.

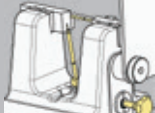
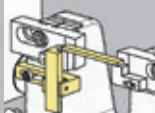
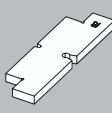
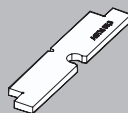
					
<b>Charpy fixture</b>	<b>Local operator protection</b>	<b>Notch alignment unit</b>	<b>Side alignment unit</b>	<b>Jig to ISO 179</b>	<b>Jig to ASTM D 6110</b>
• <b>325708</b>	• <b>325710</b>	• <b>325712</b>	• <b>325714</b>	• <b>016126</b>	• <b>016131</b>
				For adjustment of anvil span to 62 mm	For adjustment of anvil span to 101.6 mm



## Adapter plates, supports and anvils

In addition, supports- and anvils are to be determined with respect to the specimen. Dimension w in the table is the specimen's dimension in the direction of impact;

dimension h is the dimension in direction of the pendulum center of rotation. Each impact fixture should be equipped with adapter plates, supports and anvils.

Standard	Dimension w	Adapter plate	Dimension h	Support	Anvil	Span
ISO 179-1	10 mm	• <b>325720</b>	4 mm	• <b>325730</b>	• <b>325716</b>	62 mm
	6 mm	• <b>325724</b>	6 mm	• <b>325732</b>	• <b>325716</b>	62 mm
	4 mm	• <b>325726</b>	10 mm	• <b>325734</b>	• <b>325716</b>	62 mm
	15 mm	• <b>325722</b>	3 mm	• <b>325728</b>	• <b>325718</b>	22...70 mm
	10 mm	• <b>325720</b>	3 mm	• <b>325728</b>	• <b>325718</b>	22...70 mm
	3 mm	• <b>325850</b>	15 mm	• <b>325736</b>	• <b>325718</b>	22...70 mm
	3 mm	• <b>325850</b>	10 mm	• <b>325734</b>	• <b>325718</b>	22...70 mm
ASTM D6110	12.7 mm (1/2")	• <b>325752</b>	3.17 mm (1/8")	• <b>325754</b>	• <b>325750</b>	101.6 mm (4")
	12.7 mm (1/2")	• <b>325752</b>	6.35 mm (1/4")	• <b>325756</b>	• <b>325750</b>	101.6 mm (4")
	12.7 mm (1/2")	• <b>325752</b>	12.7 mm (1/2")	• <b>325758</b>	• <b>325750</b>	101.6 mm (4")

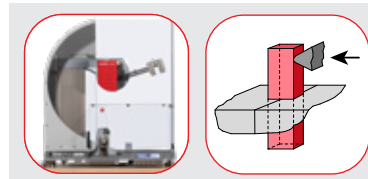

## HIT5.5P - Izod tests

## Impact fixtures

Since the clamping force of the Izod fixture may directly influence the test results, two Izod fixtures are available.

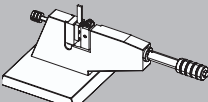
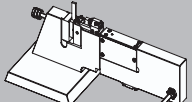
	
<b>Izod fixture, manual</b>	<b>Izod fixture, pneumatic</b>
• <b>325774</b>	• <b>325772</b>

The fixture with manual clamping transmits the torque to the jaws without friction loss, while the pneumatically operated fixture applies constant, adjustable clamping pressure to the specimen.

Operation is quick and easy via the integral pneumatic switch and is ideal for high volume testing.

A notch alignment unit is already included in the scope of supply of both units. Inserts are required to adjust the position the specimens to be tested.

## Inserts

Standard	Specimen dimension w	Specimen dimension h	Insert
ISO 180	10 mm	4 mm	• <b>325776</b>
	10 mm	3 mm	• <b>325778</b>
ASTM D 256	12.7 mm (1/2")	3.17 mm (1/8")	• <b>325780</b>
ASTM D 4812	12.7 mm (1/2")	6.35 mm (1/4")	• <b>325782</b>
	12.7 mm (1/2")	12.7 mm (1/2")	• <b>325784</b>

## Pendulums

	<b>Impact energy</b>	<b>Conventional pendulum</b>	<b>Instrumented pendulum</b>
	1 J (0.74 ft lbf)	• <b>325786</b>	
	2.75 J (2.03 ft lbf)	• <b>325788</b>	• <b>021790</b>
	5.5 J (4.06 ft lbf)	• <b>325790</b>	• <b>021792</b>
	(Pendulums can be used for all standards)		
	Impact velocity: 3.46 m/s		

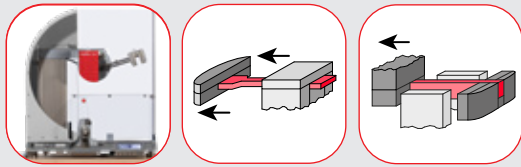

## HIT5.5P - Tensile impact tests

### Tensile impact fixture, yokes and pendulums

Standard	Tens. impact fixture	Yoke	Mass	Impact energy, Pendulum	Impact velocity	
ISO 8256 Method A	• <b>325682</b>	• <b>325684</b> • <b>325686</b>	15 g 30 g	2 J 4 J	• <b>325688</b> • <b>325690</b>	2.9 m/s 2.9 m/s
ISO 8256 Method B	• <b>325692</b>	• <b>325848</b> • <b>038197</b>	15 g	2 J 4 J	• <b>325696</b> • <b>325698</b>	2.9 m/s 2.9 m/s
ASTM D 1822	• <b>325692</b>	• <b>325848</b> • <b>038197</b>	15 g	1.35 J (1 ft lbf) 2.7 J (2 ft lbf) 5.4 J (4 ft lbf)	• <b>325999</b> • <b>325804</b> • <b>325806</b>	3.46 m/s 3.46 m/s 3.46 m/s

### Clamping units for tests to ISO 8256 and ASTM D 1822

Simplifies effective clamping of the specimen in the yoke. Clamping template and jig are required.

Standard	Specimen type	Clamping template	Clamping jig
ISO 8256 Method A	Type 1 Type 2 Type 3 Type 4	• <b>325672</b> • <b>325674</b> • <b>325676</b> • <b>325678</b>	• <b>325798</b> (Clamping jig can be used for all types of standards)
ISO 8256 Method B	Type 2 Type 4	• <b>325674</b> • <b>325678</b>	
ASTM D 1822	Type S / 9.53 mm (0.375") Type L / 9.53 mm (0.375") Type S / 12.71 mm (0.5") Type L / 12.71 mm (0.5")	• <b>325800</b> • <b>325802</b> • <b>325950</b> • <b>325952</b>	

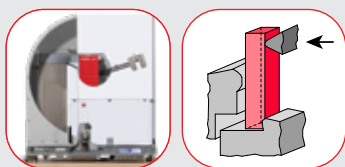

## HIT5.5P - Dynstat tests

### Impact fixture and pendulum

Standard	Dynstat impact fixture	Potential energy	Pendulum	Impact velocity
DIN 53435	• <b>325808</b>	0.2 J 0.5 J 1 J 2 J 4 J	• <b>325948</b> • <b>325810</b> • <b>325812</b> • <b>325814</b> • <b>325996</b>	2.2 m/s 2.2 m/s 2.2 m/s 2.2 m/s 2.2 m/s

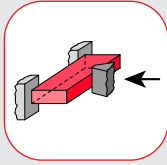

## HIT25P / HIT50P - Charpy tests

### Selecting impact pendulums

As well as specifying the working range, which lies between 10% and 80% of potential energy, the ISO standards also stipulate that the largest appropriate impact pendulum from the series of standards must always be used for the test. Due to the narrow overlap between the ranges of use, pendulum changes are required relatively frequently in practice. To meet this demand, HIT pendulum impact testers are equipped with a quick-change device. Pendulum changes are performed in seconds and thanks to the automatic pendulum identification technology, without any further input from the operator.

To avoid the risk of confusion, add-on weights to increase the energy capacity are generally not used by ZwickRoell. In the case of Charpy impact tests to ISO standards, it is usually possible to dispense with the use of the 4-joule pendulum.

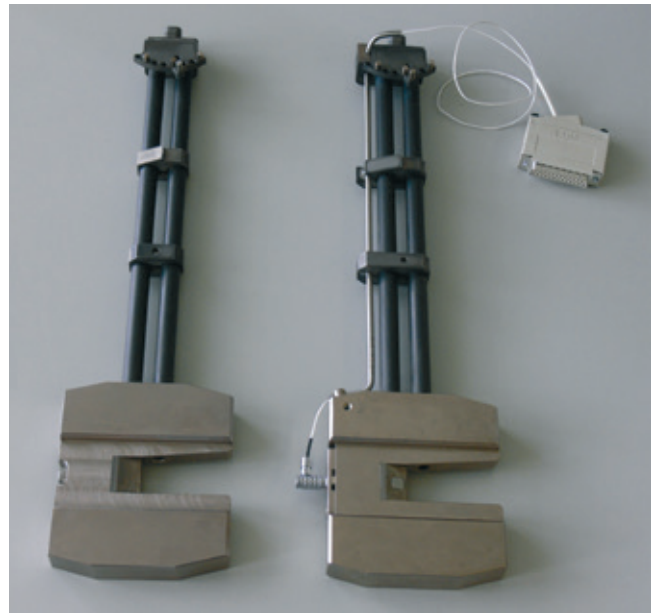

Fig. 1: Conventional and instrumented pendulum

Standard	Impact energy	Pendulum conventional	Pendulum instrumented	Impact velocity	
ISO 179-1 (conventional)	0.5 J	• 325738	-	2.9 m/s	
	ISO 179-2 (instrumented)	1 J	• 325740	-	2.9 m/s
		2 J	• 325742	• 021764	2.9 m/s
		4 J	• 325744	-	2.9 m/s
		5 J	• 325746	• 021768	2.9 m/s
		7.5 J	• 326110	• 021771	3.8 m/s
		15 J	• 326112	• 021776	3.8 m/s
25 J	• 326114	• 021779	3.8 m/s		
ASTM D 6110	50 J	• 326116	• 021780	3.8 m/s	
	0.5 J (0.37 ft lbf)	• 325762	-	3.46 m/s	
	1 J (0.74 ft lbf)	• 325764	-	3.46 m/s	
	2.7 J (2 ft lbf)	• 325766	• 021781	3.46 m/s	
	5.4 J (4 ft lbf)	• 325768	• 021782	3.46 m/s	
	10.8 J (8 ft lbf)	• 326118	• 021784	3.46 m/s	
21.6 J (16 ft lbf)	• 326120	• 021785	3.46 m/s		
<b>Pendulum sets</b>					
ISO 179-1	4 J and 5 J	• 325748	-	2.9 m/s	
	15 J and 25 J	• 016340	-	3.8 m/s	
ASTM D 6110	2.7 J and 5.4 J (2 ft lbf and 4 ft lbf)	• 325770	-	3.46 m/s	



## Charpy fixture and accessories

A local operator protection is available as an option for the Charpy fixture. Two alignment units are also available; these differ according to how the notch is produced.

If the notching is carried out with a lateral stop, there is a fixed distance between the side of the specimen and

the notch. In this case, the side alignment unit is the more practical solution, being quick and reliable.

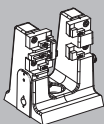

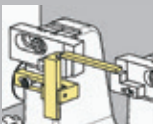
If there is no fixed distance between notch and specimen side, it is necessary to center directly on the specimen. In this case, the central notch alignment unit is required.

			
<b>Charpy fixture</b> for plastic applications • <b>326106</b>	<b>Local operator protection</b> • <b>325710</b>	<b>Notch alignment unit</b> • <b>326108</b>	<b>Side alignment unit</b> for plastic applications • <b>325714</b>

## Jigs

For adjustment of the abutments and adjustment of the tup to the abutments.

The notch alignment unit can also be precisely adjusted.



	
<b>Jig to ISO 179</b> span to 62 mm • <b>016126</b>	<b>Jig to ASTM D6110</b> span to 101.6 mm • <b>016131</b>

## Adapter plates, supports and anvils

In addition, supports and anvils are to be determined with respect to the specimen. Dimension w in the table is the specimen's dimension in the direction of impact; dimension h is the dimension in direction of the pendulum center of rotation. Each impact fixture should be equipped with adapter plates, supports and anvils.

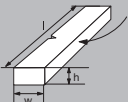
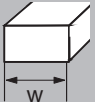
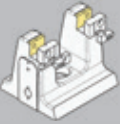

Fig. 1: Charpy fixture with local operator protection, opened

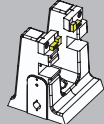
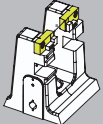
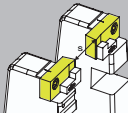
						
Standard	Dimension w	Adapter plate	Dimension h	Support	Anvil	Span s
ISO 179-1	10 mm	• <b>325720</b>	4 mm	• <b>325730</b>	• <b>325716</b>	62 mm
	6 mm	• <b>325724</b>	6 mm	• <b>325732</b>	• <b>325716</b>	62 mm
	4 mm	• <b>325726</b>	10 mm	• <b>325734</b>	• <b>325716</b>	62 mm
	15 mm	• <b>325722</b>	3 mm	• <b>325728</b>	• <b>325718</b>	22...70 mm
	10 mm	• <b>325720</b>	3 mm	• <b>325728</b>	• <b>325718</b>	22...70 mm
	3 mm	• <b>325850</b>	15 mm	• <b>325736</b>	• <b>325718</b>	22...70 mm
	3 mm	• <b>325850</b>	10 mm	• <b>325734</b>	• <b>325718</b>	22...70 mm
ASTM D 6110	12.7 mm (1/2")	• <b>325752</b>	3.17 mm (1/8")	• <b>325754</b>	• <b>325750</b>	101.6 mm (4")
	12.7 mm (1/2")	• <b>325752</b>	6.35 mm (1/4")	• <b>325756</b>	• <b>325750</b>	101.6 mm (4")
	12.7 mm (1/2")	• <b>325752</b>	12.7 mm (1/2")	• <b>325758</b>	• <b>325750</b>	101.6 mm (4")



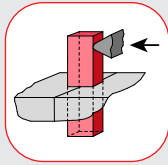

## HIT25P / HIT50P - Izod tests

### Impact fixtures

Since the clamping force of the Izod fixture may directly influence the test results, two Izod fixtures are available:

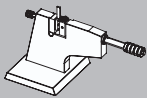

**Izod fixture, manual**

• **326124**

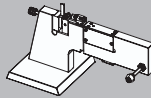

**Izod fixture, pneumatic**

• **326122**

The impact fixture with manual clamping transfers the torque without friction losses when closing to the clamping jaws.

The pneumatically operated fixture applies constant, adjustable gripping pressures to the specimens. An integrated air break switch enables it to be activated quickly and easily, and is also extremely suitable for mass testing.

A notch alignment unit is already included in the scope of supply of both units. Inserts are required to adjust the position the specimens to be tested.

### Inserts

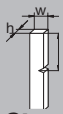

**Standard**

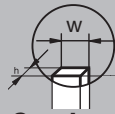

**Specimen dimension w**

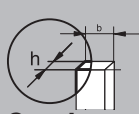

**Specimen dimension h**

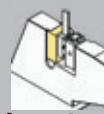

**Insert**

	Specimen dimension w	Specimen dimension h	Insert
ISO 180	10 mm	4 mm	• <b>325776</b>
	10 mm	3 mm	• <b>325778</b>
ASTM D 256	12.7 mm (1/2")	3.17 mm (1/8")	• <b>325780</b>
ASTM D 4812	12.7 mm (1/2")	6.35 mm (1/4")	• <b>325782</b>
	12.7 mm (1/2")	12.7 mm (1/2")	• <b>325784</b>

### Pendulums



Impact energy	Conventional pendulum	Instrumented pendulum
1 J (0.74 ft lbf)	• <b>325786</b>	-
2.75 J (2.03 ft lbf)	• <b>325788</b>	• <b>021790</b>
5.5 J (4.06 ft lbf)	• <b>325790</b>	• <b>021792</b>
11 J (8.14 ft lbf)	• <b>326126</b>	• <b>021794</b>
22 J (16.28 ft lbf)	• <b>326128</b>	• <b>021802</b>
44 J (32.56 ft lbf)	• <b>017324</b> <sup>(1)</sup>	• <b>021803</b> <sup>(1)</sup>
Pendulum set		
11 J and 22 J	• <b>016343</b>	-
Impact velocity 3.46 m/s		

<sup>(1)</sup> only for ASTM D256, all others can be used for all standards

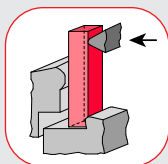

## HIT25P / HIT50P - Dynstat tests

### Impact fixture and pendulum

Standard	Dynstat impact fixture	Potential energy	Pendulum	Impact velocity
DIN 53435	• <b>326156</b>	0.2 J	• <b>325948</b>	2.2 m/s
		0.5 J	• <b>325810</b>	2.2 m/s
		1 J	• <b>325812</b>	2.2 m/s
		2 J	• <b>325814</b>	2.2 m/s
		4 J	• <b>325996</b>	2.2 m/s

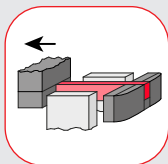
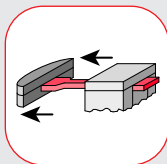

## HIT25P / HIT50P - Tensile impact tests

### Tensile impact fixture, yokes and pendulums

Standard	Tensile impact fixture /instrumented	Yoke	Mass	Impact energy	Pendulum	Impact velocity
ISO 8256 Method A	• <b>326241</b>	• <b>325684</b>	15 g	2 J	• <b>325688</b>	2.9 m/s
	• <b>325682/028966/038216</b>	• <b>325686</b>	30 g	4 J	• <b>325690</b>	2.9 m/s
			60 g	7.5 J	• <b>326132</b>	3.8 m/s
			120 g	15 J	• <b>326134</b>	3.8 m/s
			25 J	• <b>326136</b>	3.8 m/s	
			50 J	• <b>326138</b>	3.8 m/s	
ISO 8256 Method B	• <b>326130</b>	• <b>325848</b>	15 g	2 J	• <b>325696</b>	2.9 m/s
	• <b>325692</b>	• <b>038197</b>	15 g	4 J	• <b>325698</b>	2.9 m/s
		• <b>326247</b>	30 g	7.5 J	• <b>326142</b>	3.8 m/s
		• <b>326150</b>	120 g	15 J	• <b>326144</b>	3.8 m/s
		25 J	• <b>326146</b>	3.8 m/s		
		50 J	• <b>326148</b>	3.8 m/s		
ASTM D 1822	• <b>326130</b>	• <b>325848</b>	15 g (0.033 lb)	1.35 J (1 ft lb)	• <b>325999</b>	3.46 m/s
		• <b>038197</b>	15 g (0.033 lb)	2.7 J (2 ft lb)	• <b>325804</b>	3.46 m/s
			5.4 J (4 ft lb)	• <b>325806</b>	3.46 m/s	
		• <b>326278</b>	60 g (0.132 lb)	10.8 J (8 ft lb)	• <b>326152</b>	3.46 m/s
			21.6 J (16 ft lb)	• <b>326154</b>	3.46 m/s	

#### Instrumentation:

The supports • **028966** / • **038216** are the instrumented versions of support 325682 (ISO 8256, Method A). They differ in the nominal power of the included piezo load cell: 2.5 kN / 10 kN. Pendulum and yokes can be selected from the standard product program in the range from 7.5 up to 50 Joule.

### Clamping units for tests to ISO 8256 and ASTM D 1822

Simplifies a rectangular clamping of the specimen in the yoke. For this clamping template and jig are required.

Standard	Specimen type	Clamping template	Clamping jig
ISO 8256 Method A	Type 1	• <b>325672</b>	• <b>325798</b> (Clamping jig can be used for all types of standards)
	Type 2	• <b>325674</b>	
	Type 3	• <b>325676</b>	
	Type 4	• <b>325678</b>	
ISO 8256 Method B	Type 2	• <b>325674</b>	
	Type 4	• <b>325678</b>	
ASTM D 1822	Type S / 9.53 mm (0.375")	• <b>325800</b>	
	Type L / 9.53 mm (0.375")	• <b>325802</b>	
	Type S / 12.71 mm (0.5")	• <b>325950</b>	
	Type L / 12.71 mm (0.5")	• <b>325952</b>	

## 4.2 Testing Metals

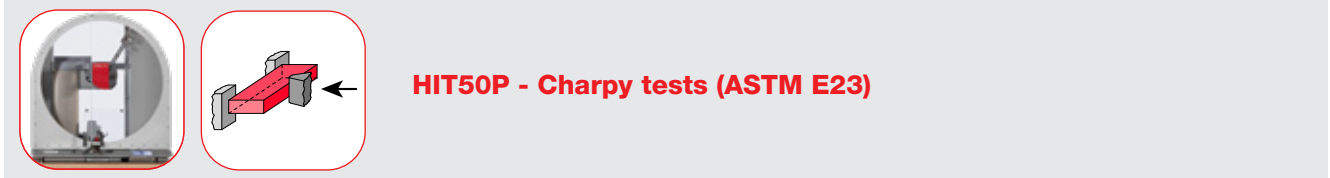

**HIT50P - Charpy tests (ASTM E23)**

### Pendulum, fixture and accessories to ASTM E23

A local operator protection with notch alignment is available as an option for the Charpy fixture. The notch-alignment unit is required to align the specimen notch with the center.

When using the side alignment fixture, the specimens are aligned to their front faces. The available stop can be swiveled. The alignment unit can be fixed on the left or right, top or bottom of the impact fixture.

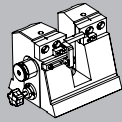
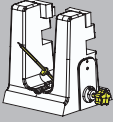
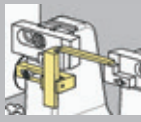
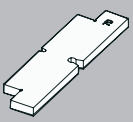
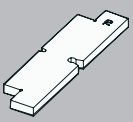
				
Pendulum conventional	Local operator protection	Charpy fixture	Notch alignment unit	Side alignment unit
50 J 3.8 m/s • 030849	• 325710	for metal applications • 030676	• 326108	for metal applications • 030844
				
				Jig to ASTM E23 span to 40 mm • 1016465

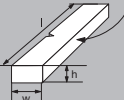
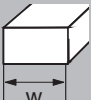
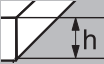
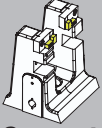
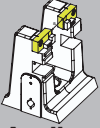
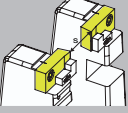
					
Standard	Dimension w	Dimension h	Support	Anvil	Span s
ASTM E 23	10 mm	10 mm	• 030802	• 030800	40 mm
	10 mm	7.5 mm	• 030840	• 030800	40 mm
	10 mm	5 mm	• 030842	• 030800	40 mm
	10 mm	2.5 mm	• 030843	• 030800	40 mm

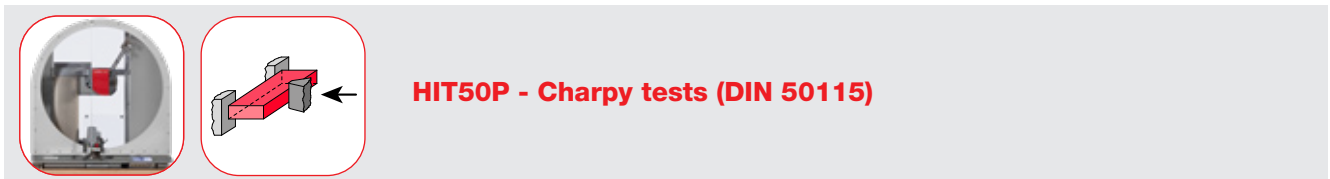

**HIT50P - Charpy tests (DIN 50115)**

DIN 50155 was withdrawn and replaced mainly by ISO 148:

- DIN EN ISO 148-1 (Test standard for metals > 50 J),
  - DIN EN ISO 148-2 (Test standard for metals > 300 J)
- and
- DIN EN ISO 148 Supplement 1 (DVM 10 x 10 mm, DVMK 6 x 6 mm)

The smallest samples (3 x 4 mm) are no longer included in this standard. To be able to test them further on the HIT50P the following accessories are necessary.

Specification	
Pendulum	(see Charpy pendulums to ISO 179, plastics)
Charpy fixture	• 326106
Notch alignment unit	• 326108
Side alignment unit	• 325714
Jig for adjustment of anvil span to 22 mm	• 016124
Adapter plate	• 325726
Dimension w: 4 mm, dimension h: 3 mm	
Support	• 325728
Anvil	• 325718
(span s: 22 mm)	

**ZwickRoell**

August-Nagel-Str. 11  
D-89079 Ulm  
Phone+49 7305 10 - 0  
Fax +49 7305 10 - 11200  
info@zwickroell.com  
www.zwickroell.com

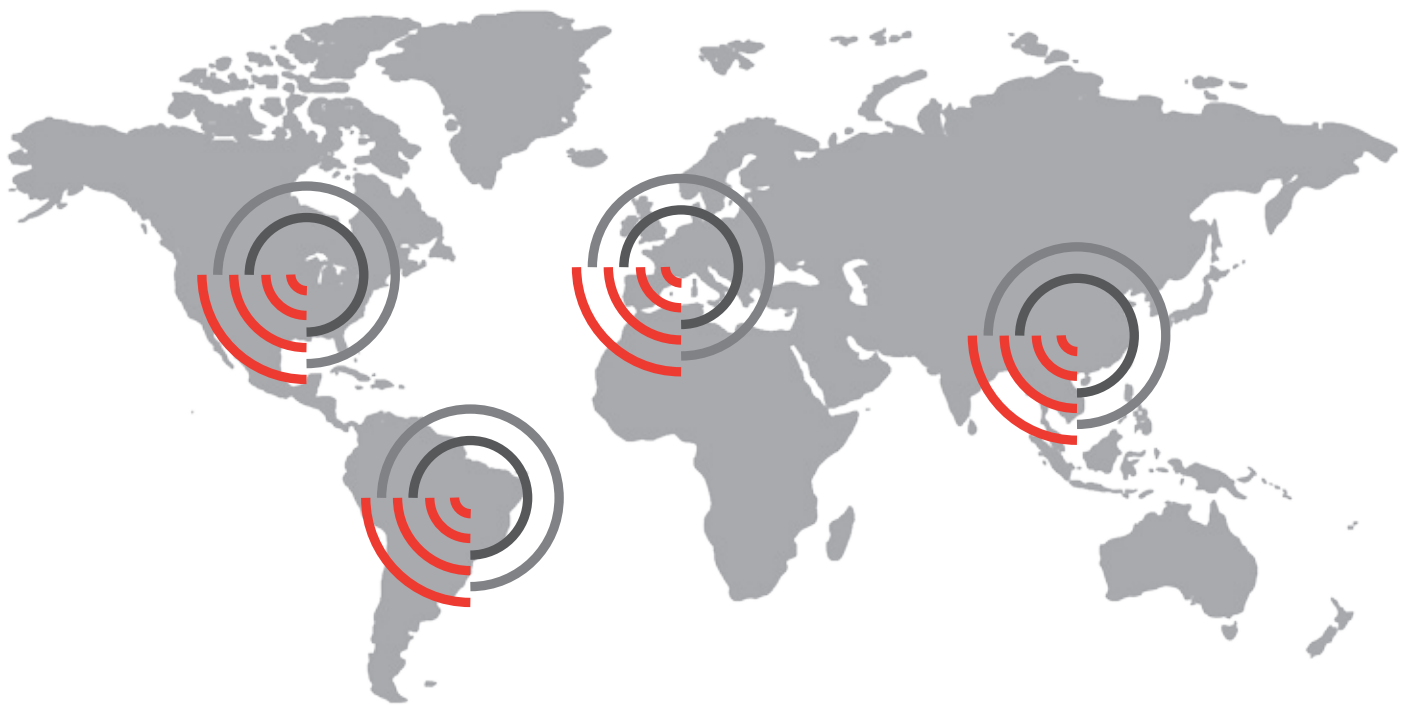

**Find your local company – worldwide**  
[www.zwickroell.com](http://www.zwickroell.com)